







ST 110 201 5892



- saillie 235 mm
- bec pivotant 360°
- jet enrichi en air et jet douchette
- hauteur de robinetterie 370 mm
- hauteur de la douchette pendulaire environ 665 mm
- hauteur jusqu'au mousseur 212 mm
- diamètre de percement du bec 35 mm
- diamètre de percement des robinets latéraux 32 mm
- diamètre de percement douchette pendulaire 30 mm
- inverseur automatique sortie/douchette
- tête de douchette avec système anticalcaire
- débit d'eau maxi. 7 l/min avec une pression d'écoulement de 3 bars
- sans plomb
- Ce produit contribue au respect des exigences des systèmes d'évaluation des bâtiments écologiques, par exemple LEED®, BREEAM®, DGNB

	Chrome	ST 110 201 5892-00
	Platine brossé	ST 110 201 5892-06
	Platine	ST 110 201 5892-08
	Dark Chrome	ST 110 201 5892-19
	Chrome brossé	ST 110 201 5892-93
	Dark Platinum brossé	ST 110 201 5892-99

Composants individuels de ce set

Ce set requiert les composants suivants



1x 20 815 892-00



1x 27 789 970-00



TARA Mélangeur à trois trous avec douchette pendulaire - Chrome

TARA

ST 110 201 5892

ST 110 201 5892



- saillie 235 mm
- bec pivotant 360°
- jet enrichi en air
- hauteur de robinetterie 370 mm
- hauteur jusqu'au mousseur 212 mm
- diamètre de percement du bec 35 mm
- diamètre de percement des robinets latéraux 32 mm
- débit d'eau maxi. 7 l/min avec une pression d'écoulement de 3 bars
- sans plomb
- Ce produit contribue au respect des exigences des systèmes d'évaluation des bâtiments écologiques, par exemple LEED®, BREEAM®, DGNB

	Chrome	20 815 892-00
	Platine brossé	20 815 892-06
	Platine	20 815 892-08
	Laiton (Or 23cts)	20 815 892-09
	Dark Chrome	20 815 892-19
	Laiton brossé (Or 23cts)	20 815 892-28
	Noir mat	20 815 892-33
	Champagne brossé (Or 22cts)	20 815 892-46
	Champagne (Or 22cts)	20 815 892-47
	Chrome brossé	20 815 892-93
	Dark Platinum brossé	20 815 892-99

Accessoires recommandés



Commande de vidage individuelle manuelle 10 710 970-00
Commande manuelle - Chrome

Accessoires recommandés



Distributeur avec rosace - Chrome 82 444 970-00

ST 110 201 5892



Diagramme de débit



Certificats

WRAS_2107052.

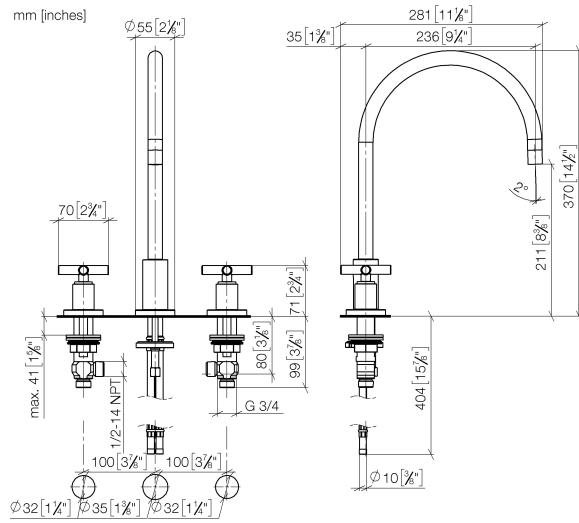
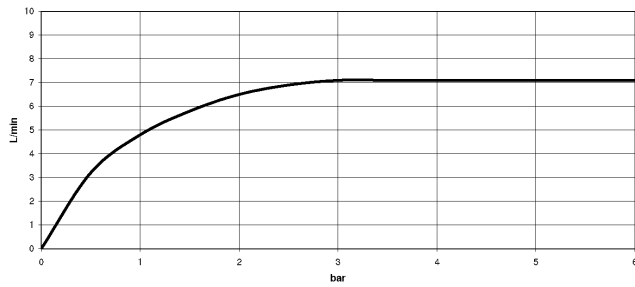
ETA_18514.

LGA_19166.

GDV_0400289.

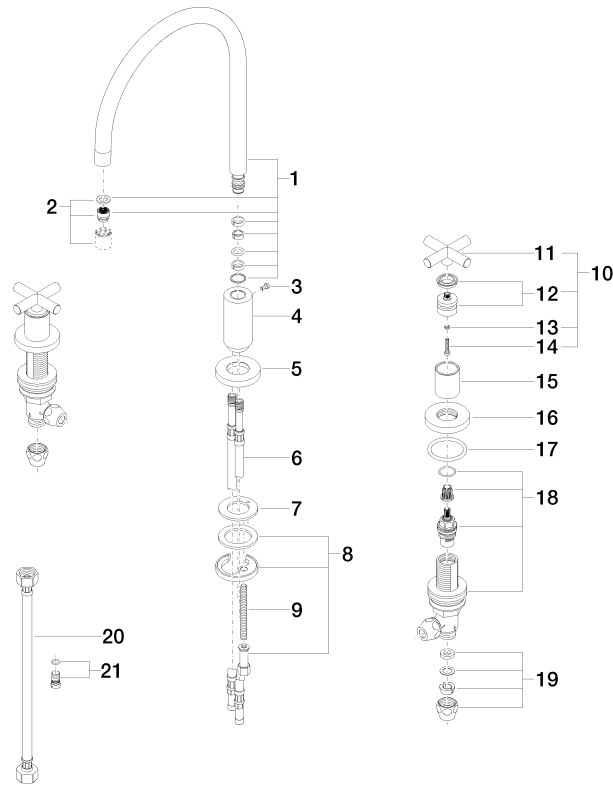

Liste des pièces de rechange

N°	Article Numéro	Désignation	Fréquence de montage	Délai de livraison
1	90 28 22 226 01-00	bec déverseur	1	10
2	90 23 01 028 03-00	mousseur	1	10
3	09 30 30 057 90	vis	1	2
4	09 11 10 088 10-00	raccord	1	10
5	09 28 10 140-00	anneau	1	10
6	04 30 04 064 00 90	flexible	2	60
7	09 14 05 047 90	joint	1	2
8	04 30 11 038 00 90	set de fixation	1	2
9	09 31 11 011 90	tige	1	2
10	90 20 89 010 10-00	poignée	2	10
11	09 20 89 010-00	poignée	2	60
12	90 12 12 007 00-00	prise	2	10
13	90 30 11 029 00 90	rondelle	2	2
14	90 30 30 075 00 90	vis	2	2
15	09 21 02 140-00	douille	2	10
16	09 27 89 105-00	rosace	2	10
17	90 14 10 043 00 90	joint	2	2
18	90 17 11 040 51 90	partie latérale	2	2
19	90 23 30 040 00-00	joint américain	4	10
20	12 501 970 90	Flexible de pression 1/2" x 1/2" x 300 mm -	2	-
La pièce de rechange ne peut plus être commandée, veuillez commander l'article de remplacement				
21	04 31 20 046 10 92	set	1	2

ST 110 201 5892









S'adapte aux gammes suivantes : ELIO,
TARA, TARA ULTRA

- jet douchette
- inverseur automatique bec/douchette pendulaire
- hauteur de robinetterie 665 mm
- rosace individuelle Ø 55 mm
- diamètre de percement douchette pendulaire 30 mm
- tête de douchette avec système anticalcaire
- sans plomb

Uniquement combinable avec 33826790, 32800790,
33826888, 32815888, 20815892, 33826875.

Avec sécurité anti-retour.

	Chrome	27 789 970-00
	Platine brossé	27 789 970-06
	Platine	27 789 970-08
	Dark Chrome	27 789 970-19
	Chrome brossé	27 789 970-93
	Dark Platinum brossé	27 789 970-99

ST 110 201 5892

mm [inches]
M 1:10



Diagramme de débit



Certificats

LGA_18901.

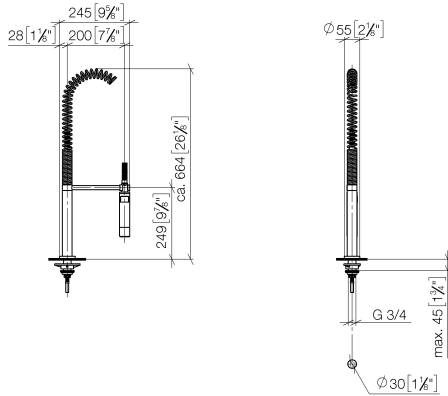
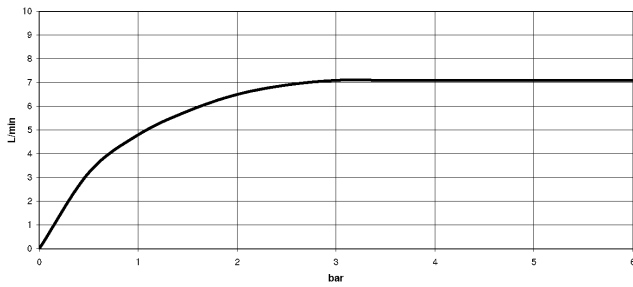
LGA_28304.

Belgaqua_22_277_2
7_3.

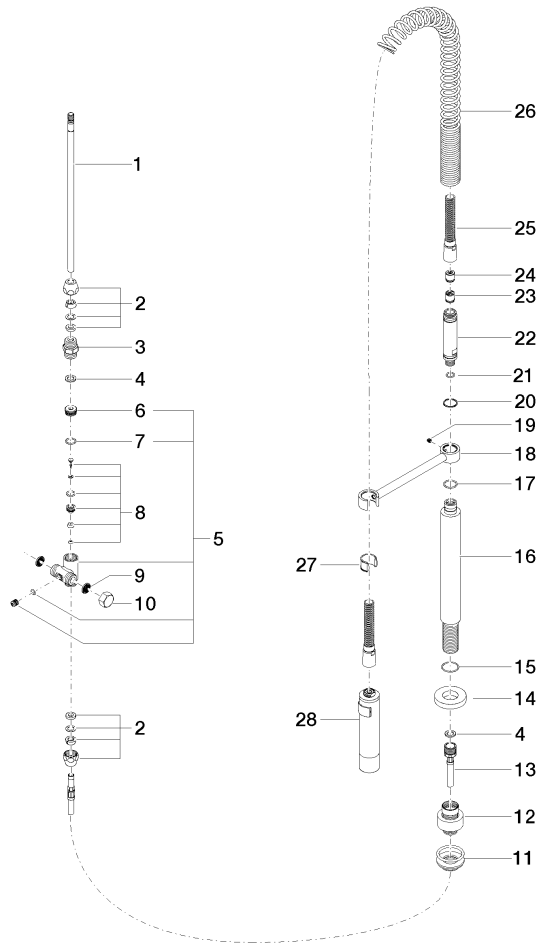

ST 110 201 5892

Liste des pièces de rechange

N°	Article Numéro	Désignation	Fréquence de montage	Délai de livraison
1	04 24 02 046 01-07	tuyau	1	10
2	90 23 30 040 00-00	joint américain	2	10
3	90 24 03 168 00 90	raccord à vis	1	2
4	90 14 20 002 00 90	joint	2	2
5	90 17 09 046 10 90	inverseur	1	2
6	09 24 04 112 10 90	raccord à vis	1	2
7	90 14 10 033 00 90	joint	1	2
8	90 21 10 031 10 90	inverseur	1	2
9	09 23 01 039 90	tamis	2	2
10	04 21 02 006 00 92	capuchon	1	2
11	04 23 10 004 03 90	set de fixation	1	2
12	12 780 970 90	Set de rallonges -	1	60
13	09 30 04 067 90	flexible	1	2
14	09 28 10 064-00	rosace	1	10
15	09 14 10 120 90	joint	1	2
16	09 11 10 066 10-00	raccord	1	60
17	09 14 10 031 90	joint	1	2
18	04 17 20 014 00-00	patte de fixation	1	10
19	09 31 11 049 90	tige	1	2
20	09 14 15 012 90	anneau	1	2
21	09 14 10 003 90	joint	1	2
22	09 30 01 067 10-00	adaptateur	1	10
23	90 23 01 141 00 90	anti-retour	1	2
24	09 23 01 046 90	anti-retour	1	2
25	90 30 02 065 00-00	flexible	1	10
26	09 16 02 034 90	ressort	1	2
27	90 18 40 035 00 90	douille	1	2
28	04 12 11 094 10-00	douche	1	10

